

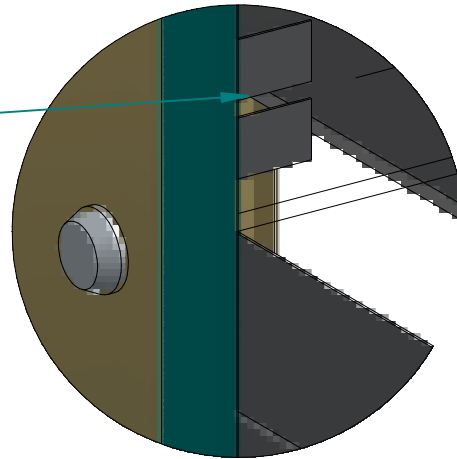

Ramka regulowana

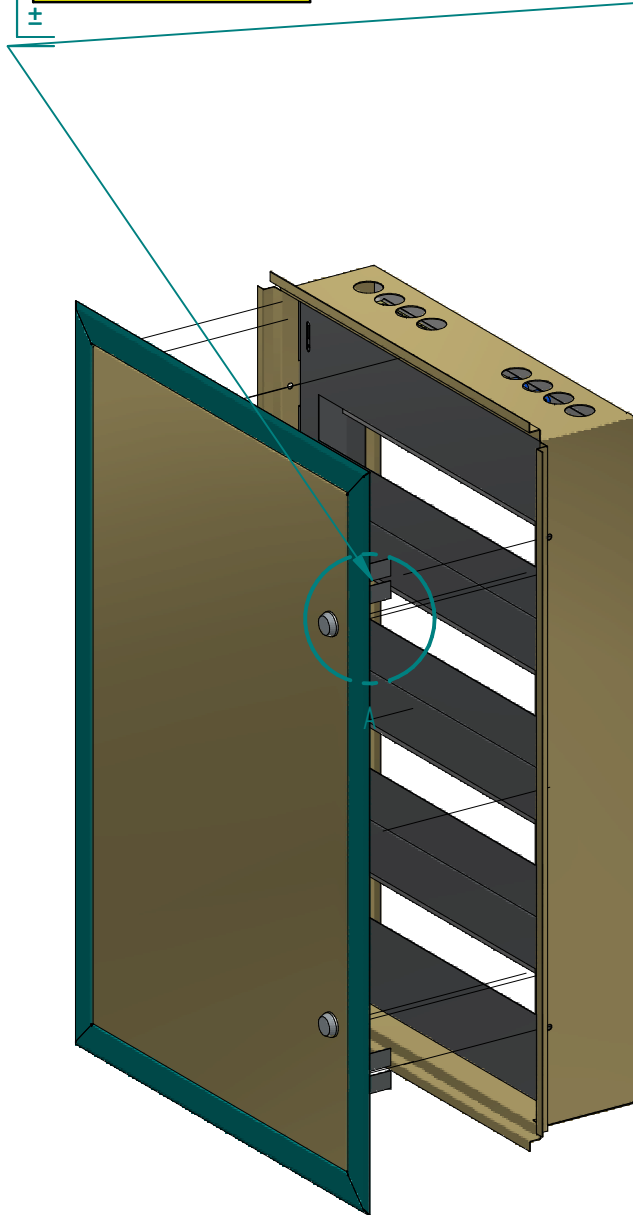

SZCZEGÓŁ A

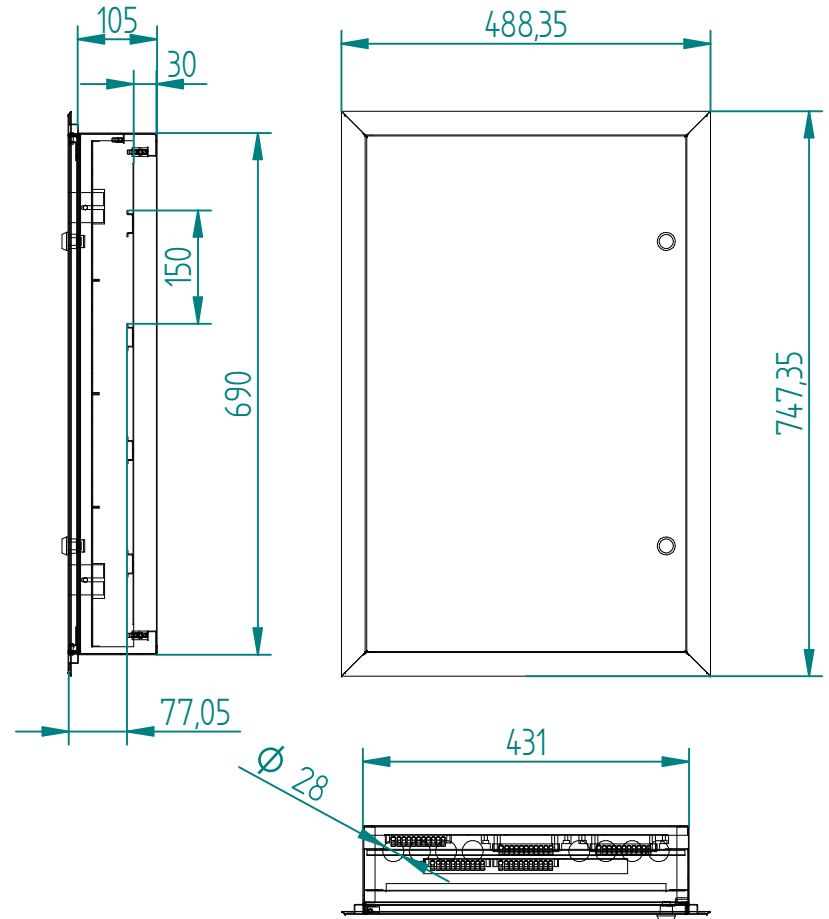

	Nazwisko	Data	Typ: RBP-80M.dft	
Rys.	Stefan	03/15/16	Formatka A4	Nr.rys.
				SHEET 1 OF 1