

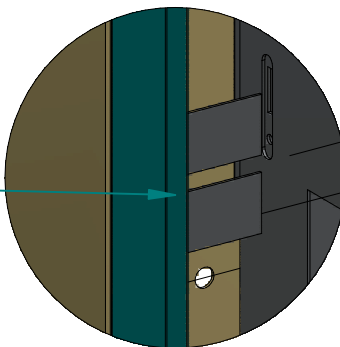

Ramka regulowana

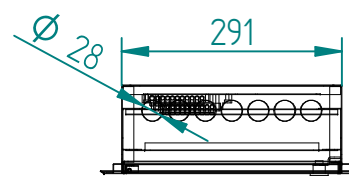

SZCZEGÓŁ A

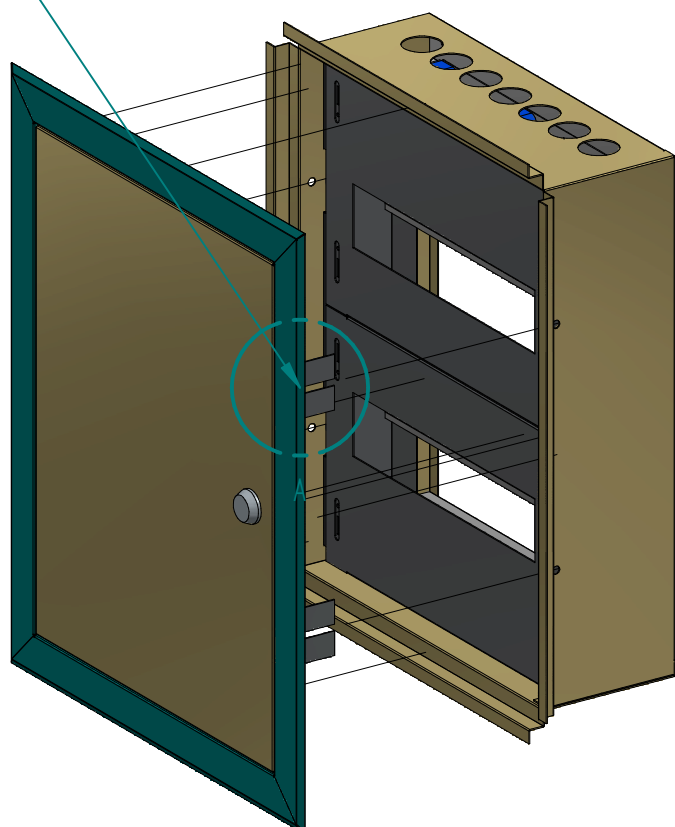
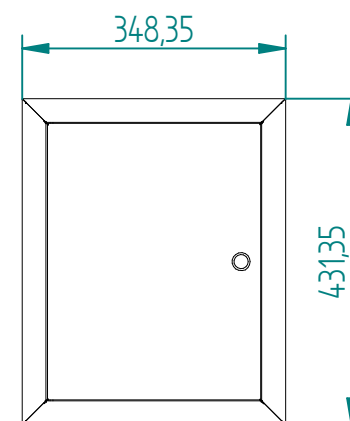
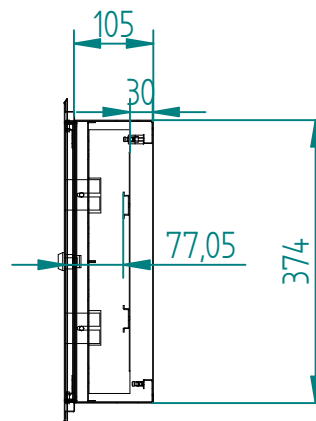

	Nazwisko	Data	Typ: RBP-24M.dft	
Rys.	Stefan	03/11/16	Formatka A4	Nr.rys.
			SHEET 1 OF 1	